

IEG1-1-63-25.0-91-V

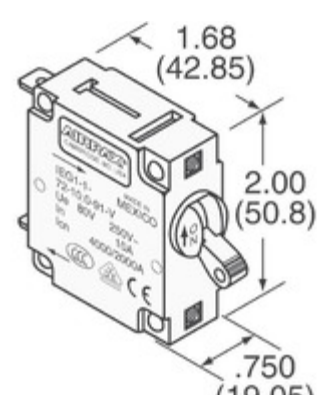

Obrázky jsou pouze orientační.
Podrobné informace o produktu naleznete v části Technické údaje produktu.
Koupit IEG1-1-63-25.0-91-V s důvěrou od Component-World.HK, 1 rok záruka



Part Number: [IEG1-1-63-25.0-91-V](#)

Výrobce: [Sensata Technologies, Airpax](#)

Popis: CIR BRKR MAG-HYDR

Datový list: [IEG, IUG, JEG, CEG, LEG Series Datasheet](#)

RoHS Status: Bez olova / V souladu RoHS

Ship From: Hong Kong

Shipment Way: DHL/Fedex/TNT/UPS/EMS

[Request For Quotation](#)















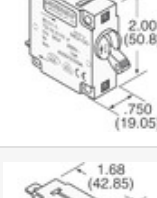
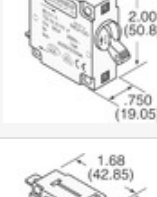
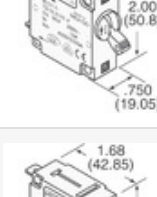
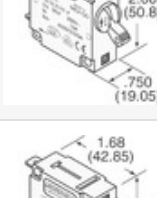

PARAMETR PRODUKTU

| | | | |
|---|--------------------------------|-----------------------------------|--|
| Part Number | IEG1-1-63-25.0-91-V | Výrobce | Sensata Technologies, Airpax |
| Popis | CIR BRKR MAG-HYDR | Stav volného vedení / RoHS | Bez olova / V souladu RoHS |
| Dostupné množství | 1821 pcs | Datový list | IAG,IUG,JEG,CEG,LEG Series Datasheet |
| Kategorie | Ochrana obvodu | Napítí - DC | 80V |
| Napítí - AC | 250V | Série | IEG |
| Počet pólů | 1 | Typ montáže | Panel Mount |
| Úroveň citlivosti na vlhkost (MSL) | 1 (Unlimited) | Stav volného vedení / RoHS | Lead free / RoHS Compliant |
| Osvětlení napětí (nominální) | - | Osvětlení | None |
| Jmenovitá hodnota proudu | 25A | Breaker Typ | Magnetic (Hydraulic Delay) |
| Pohon Type | Lever | | |

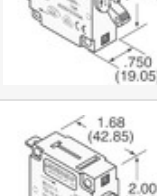
Component-World.com je spolehlivý distributor elektronických součástek. Specializujeme se na všechny elektronické komponenty řady Sensata Technologies, Airpax. Máme 1821 kusy Sensata Technologies, Airpax IEG1-1-63-25.0-91-V na skladě dostupných. Vyžádejte si citát z distributora součástí elektroniky na Component-World.com, náš prodejní tým vás bude kontaktovat do 24 hodin.

RFQ Email: info@Components-World.com

SOUVISEJÍCÍ PRODUKTY

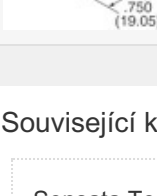
| | | | |
|--|--|--|-----------------------|
|  | Část#: IEG1-1-63-8.00-01-V | Výrobci: Sensata Technologies, Airpax | Dotaz |
| | Popis: CIR BRKR MAG-HYDR | | |
|  | Část#: IEG1-1-63-15.0-01-V | Výrobci: Sensata Technologies, Airpax | Dotaz |
| | Popis: CIR BRKR MAG-HYDR LEVER 15A | | |
|  | Část#: IEG1-1-63-10.0-01-V | Výrobci: Sensata Technologies, Airpax | Dotaz |
| | Popis: CIR BRKR MAG-HYDR LEVER 10A | | |
|  | Část#: IEG1-1-63-3.00-91-V | Výrobci: Sensata Technologies, Airpax | Dotaz |
| | Popis: CIR BRKR MAG-HYDR LEVER 3A | | |
|  | Část#: IEG1-1-63-30.0-01-V | Výrobci: Sensata Technologies, Airpax | Dotaz |
| | Popis: CIR BRKR MAG-HYDR | | |
|  | Část#: IEG1-1-63F-10.0-91-V | Výrobci: Sensata Technologies, Airpax | Dotaz |
| | Popis: CIR BRKR MAG-HYDR LEVER 10A | | |
|  | Část#: IEG1-1-62F-5.00-01-V | Výrobci: Sensata Technologies, Airpax | Dotaz |
| | Popis: CIR BRKR MAG-HYDR 5A LEVER | | |
|  | Část#: IEG1-1-63-20.0-01-V | Výrobci: Sensata Technologies, Airpax | Dotaz |
| | Popis: CIR BRKR MAG-HYDR | | |
|  | Část#: IEG1-1-63-2.50-01-V | Výrobci: Sensata Technologies, Airpax | Dotaz |
| | Popis: CIR BRKR MAG-HYDR LEVER 2.5A | | |
|  | Část#: IEG1-1-63-5.00-91-V | Výrobci: Sensata Technologies, Airpax | Dotaz |
| | Popis: CIR BRKR MAG-HYDR LEVER 5A | | |
|  | Část#: IEG1-1-62F-5.00-A-01-V | Výrobci: Sensata Technologies, Airpax | Dotaz |
| | Popis: CIR BRKR MAG-HYDR | | |
|  | Část#: IEG1-1-63F-20.0-91-V | Výrobci: Sensata Technologies, Airpax | Dotaz |
| | Popis: CIR BRKR MAG-HYDR LEVER 20A | | |
|  | Část#: IEG1-1-63F-16.0-A-01-V | Výrobci: Sensata Technologies, Airpax | Dotaz |
| | Popis: CIR BRKR MAG-HYDR LEVER 16A | | |
|  | Část#: IEG1-1-62F-7.50-01-V | Výrobci: Sensata Technologies, Airpax | Dotaz |
| | Popis: CIR BRKR MAG-HYDR | | |
|  | Část#: IEG1-1-63-25.0-01-V | Výrobci: Sensata Technologies, Airpax | Dotaz |
| | Popis: CIR BRKR MAG-HYDR LEVER 25A | | |
|  | Část#: IEG1-1-63-8.00-91-V | Výrobci: Sensata Technologies, Airpax | Dotaz |
| | Popis: CIR BRKR MAG-HYDR | | |
|  | Část#: IEG1-1-63-15.0-91-V | Výrobci: Sensata Technologies, Airpax | Dotaz |
| | Popis: CIR BRKR MAG-HYDR LEVER 15A | | |
|  | Část#: IEG1-1-63-6.00-A-01-V | Výrobci: Sensata Technologies, Airpax | Dotaz |
| | Popis: CIR BRKR MAG-HYDR | | |
|  | Část#: IEG1-1-63F-10.0-C-91-V | Výrobci: Sensata Technologies, Airpax | Dotaz |
| | Popis: CIR BRKR MAG-HYDR LEVER 10A | | |
|  | Část#: IEG1-1-63-20.0-91-V | Výrobci: Sensata Technologies, Airpax | Dotaz |
| | Popis: CIR BRKR MAG-HYDR LEVER 20A | | |

Související klíčová slova pro IEG1-1-63-25.0-91-V

| | | | |
|---|--|-------------------------------|-----------------------------|
| Sensata Technologies, Airpax IEG1-1-63-25.0-91-V. | IEG1-1-63-25.0-91-V distributor | IEG1-1-63-25.0-91-V dodavatel | IEG1-1-63-25.0-91-V Cena |
| IEG1-1-63-25.0-91-V Stáhnout datasheet. | IEG1-1-63-25.0-91-V Datasheet. | IEG1-1-63-25.0-91-V Stock. | koupit IEG1-1-63-25.0-91-V. |
| Sensata Technologies, Airpax IEG1-1-63-25.0-91-V. | Sensata Technologies/Airpax IEG1-1-63-25.0-91-V. | | |